

Features:

- InGaAsP/InP MQW FP laser diode
- PIN diode receiver with high sensitivity
- Wide operating temperature: -40~85 °C
- SC Receptacle Connector
- Data rate up to 1.25Gb/s
- ROHS Compliant



Application:

- 1.25Gbps Bit Rate application
- Single-mode 1550nm application

Electro-Optical Characteristics (T=25°C)

Parameter	Symbol	Unit	min	Typ	Max	Note
Threshold Current	I _{th}	mA		12	15	T=25°C
				32	50	T=85°C
Optical Output Power	P _o	mW	0.1		0.5	I _{th} +20mA
Forward Voltage	V _f	V		1.2	1.6	I _{th} +20mA
Peak Wavelength	λ _p	nm	1530	1550	1570	T=25°C
			1510	1550	1590	T=-40~85°C
Spectral Width (RMS)	Δλ	nm		1	3	I _{th} +20mA
Rise Time	t _r	psec.		150	300	I _b =I _{th} , 20%-80%
Fall Time	t _f	psec.		150	300	I _b =I _{th} , 80%-20%
Monitor Current	I _m	μA	100	200	400	V _r =5V

Absolute Maximum Ratings

Parameter	Symbol	Min	Max	Unit
-----------	--------	-----	-----	------

Storage Temperature	T_S	-40	85	$^{\circ}\text{C}$
Operating Temperature	T_o	-40	85	$^{\circ}\text{C}$
Storage Relative Humidity	RH_S	-	95	%
Lead Solder Temperature	T_{SLD}	-	260	$^{\circ}\text{C}$
Lead Solder Duration	t_{SLD}	-	10	s
Continuous Optical Output Power	P		120	mA
Laser Continuous Forward Current	I		2	mA
Laser Diode Reverse Voltage	V_r		2	V
PD Reverse Voltage	V_r		15	V

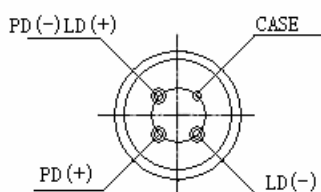
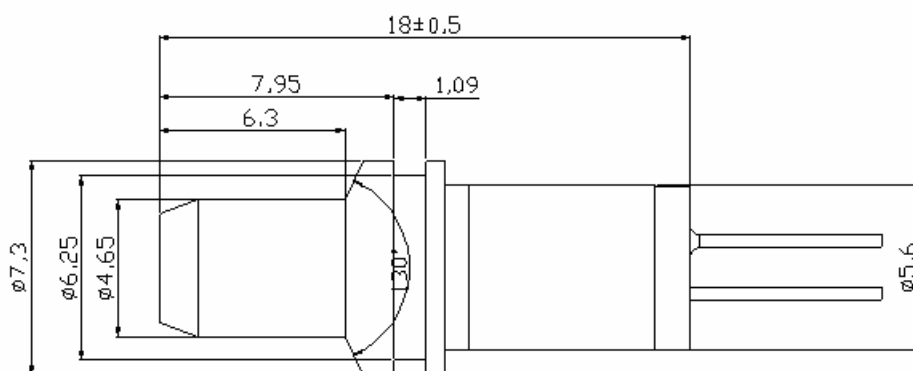

Bottom View